

zumax

Zumax Medical
Beyond Vision

New!
LED ILLUMINATION



Start your micro-surgery with ZUMAX
OMS2350 DENTAL MICROSCOPE



Mounting Options:



Floor Stand



Ceiling Mount



Wall Mount

Fixed Ground Mount



Tabletop Clip



Widefield eyepieces

The widefield eyepieces are screwed in to the tube and have integrated eyecups with stepless adjustment. The eyepieces are excellently suited for surgeons who wish to work with their eyeglasses on.

0° -180° inclinable binocular

Inclinable binoculars feature the widest range of any binocular for user comfort.

6-step magnification changer

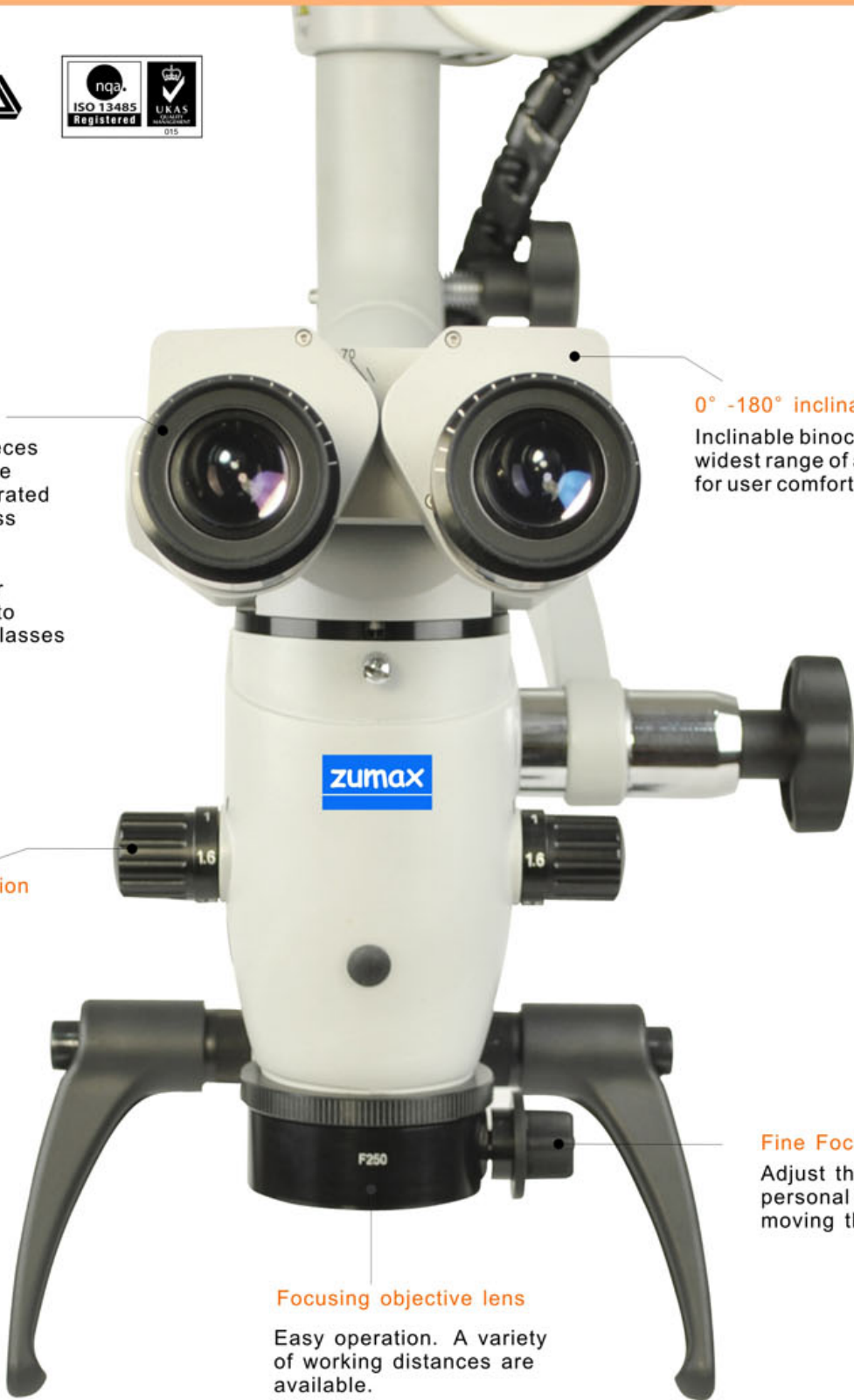

Fine Focusing

Adjust the focus to your personal needs, without moving the microscope.

Focusing objective lens

Easy operation. A variety of working distances are available.

MICROSCOPE

MICROSCOPE

MICROSCOPE

MICROSCOPE

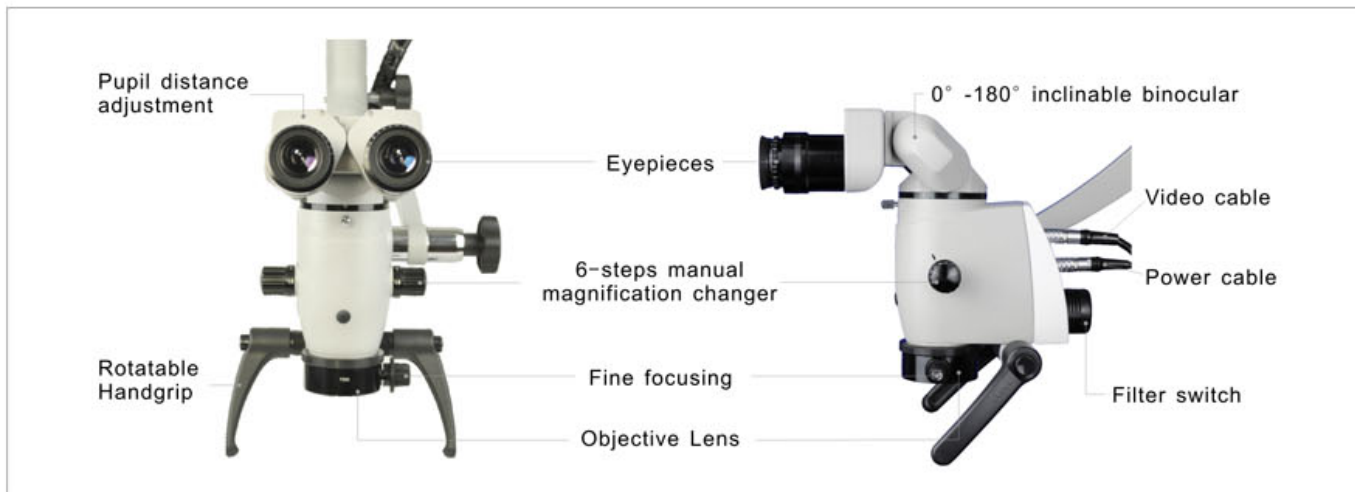

Excellent optics

German lenses, multi coatings

Lens made of imported glass from Germany to reduce the optical aberration. All of the lenses are multi-coated and anti-reflective.



6-step magnification changer

The magnification changer knobs on both sides of the microscope body allow to select fast and conveniently the optimally matched magnifications for brilliant images from an overview of an entire arch to high magnification for precision and close inspection.



example with F=250mm lens and 12. 5x eyepiece:

Magnification changer	0.33x	0.5x	0.8x	1.22x	2.0x	3.0x
Magnification	2.8x	4.2x	6.9x	10.4x	17.0x	25.6x
Diameter of Field-of-view (mm)	78.0	52.0	32.0	21.0	13.0	9.0

example with F=200mm lens and 12. 5x eyepiece:

Magnification changer	0.33x	0.5x	0.8x	1.22x	2.0x	3.0x
Magnification	3.5x	5.3x	8.6x	13.0x	21.3x	32.0x
Diameter of Field-of-view (mm)	62.6	41.7	25.6	17.00	10.4	7.0

LED Illumination

LED there be light

LEDs present many advantages over Halogen or Xenon light sources including lower energy consumption, longer lifetime, improved robustness and greater durability and reliability. In addition LEDs operate at a safe, low voltage, instead of the 250+ volts commonly found in xenon lighting, but also have a light temperature characteristic of natural daylight.



Yellow and Green integrated Filter

Yellow filter: Prevents premature curing of composite.
Green filter: Improves detail visibility by enhancing the contrast of tissue with a strong blood supply.

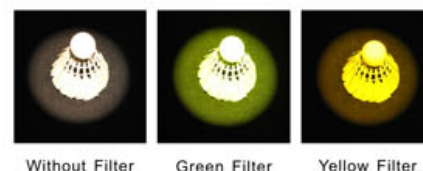

Without Filter Green Filter Yellow Filter



Brightness Control Knob

Allows you to easily adjust the light intensity for any clinical situation.



Laser Filter (Optional)

It designed to filter the laser down to eye safe levels as required under laser safety standards. Can be used with Laser wavelengths :
Diode Laser: 780–830nm; Nd-YAG: 1064nm;
Er-YAG: 2940nm.

Operating easy and comfort

0° -180° inclinable binocular

Inclinable binoculars feature the widest range of any binocular for user comfort.



Eyepiece with integrated reticule (optional)

Gives the assistant the possibility to see exactly the same image section like the surgeon. In addition it gives the operator the possibility to take photos and videos without the need of controlling the image section on an external monitor.

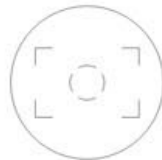

Rotatable Handgrip

Rotatable handgrip can be adjusted to user's preferred position and enable the user to easily place the OMS in the desired position.



Integrated video camera (optional)

Integrated video camera system

The integrated video camera system provides the still video and image to your patients and staffs. The microscope system can be easily moved.



Numerous accessories (optional)



An adapter for SONY NEX series HD camera

It can take up to 14 megapixel still image or a 1920×1080i MPEG-4 video and save all data onto its SD memory card.

Adapters and image devices

Beam splitter, the adapter for SLR camera, CCD camera, camcorder etc..can be attached easily.



Pendulum Function

This function allows you to remain in an upright viewing position, just change the direction of the optic pod without changing the direction of the binocular head.



Dual Iris diaphragm

Double iris diaphragm to increase the depth of field (optional).



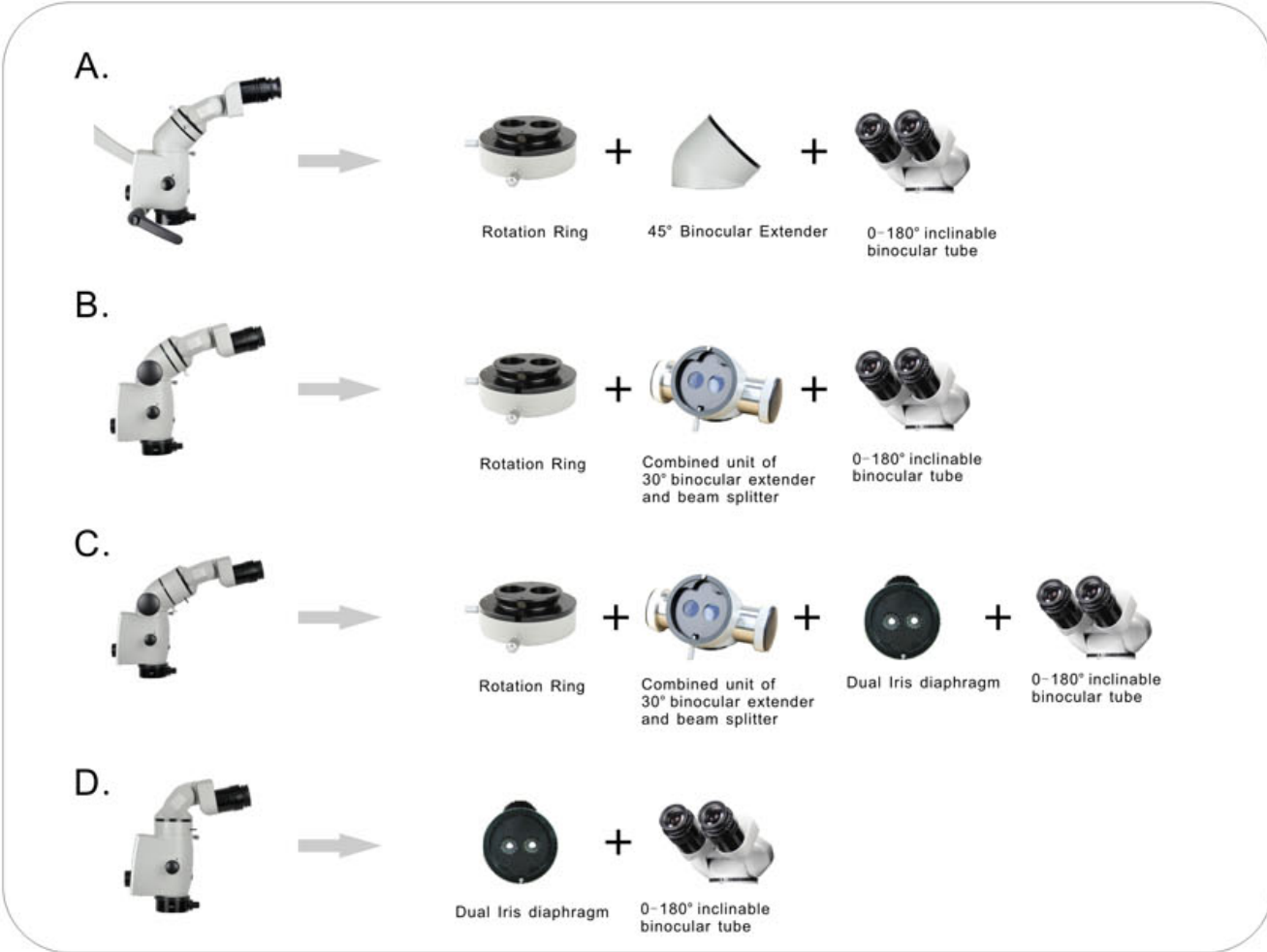

Zumax OMS designed for your practice to improve the quality of the diagnosis and the treatment.



Image courtesy: Dr. Günther Stöckl, Rottenburg, Germany



Image courtesy: Dr. Günther Stöckl, Rottenburg, Germany

Technical Data

Magnification system

- * 6-steps manual magnification changer
- * Five click stop positions
- y=0. 33x, 0. 5x, 0. 8x, 1. 22x, 2x, 3x

Tube (Optional)

- * 45° inclined binocular tube, f=170mm
- * 0° -180° inclinable binocular tube, f=170mm

Eyepieces (Optional)

- * 12. 5x, 10x, 16x and 20x widefield eyepieces and have integrated eyecups with stepless adjustment.

Magnification Rang

e. g. with f=250mm lens and 12. 5x eyepiece:

Magnification/Field-of-view diameter:

2.8x 4.2x 6.9x 10.4x 17.0x 25.6x
78mm 52mm 32mm 21mm 13mm 9mm

With selected components, the above magnification rang can be shifted up or down.

Focusing

- * Manual, fine focusing range 12mm
- * 5 objective lenses for optional:
f=200mm (with fine focus),
f=250mm (with fine focus),
f=300mm, f=350mm, f=400mm

Illumination

- * Zumax LED Illumination, supplies bright, white and shadow-free light, >20, 000 hours lifetime
- * Yellow and green integrated filter
- * Field of view diameter: 50mm with f=250mm objective lens

Gross Weight

- * Floorstand 125kg
- * Wall Mount 80kg
- * Fixed Ground Mount 75kg
- * Ceiling Mount 95kg
- * Tabletop Clip 45kg

Compliance
ISO13485

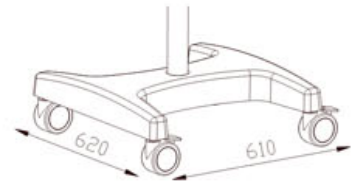
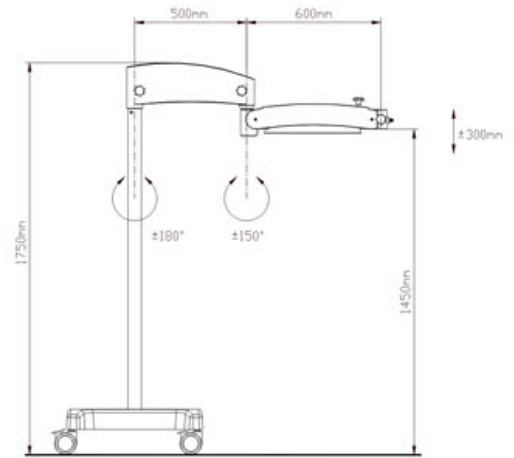

Extra Long Arm

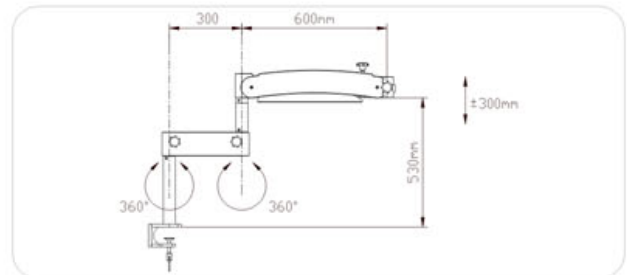
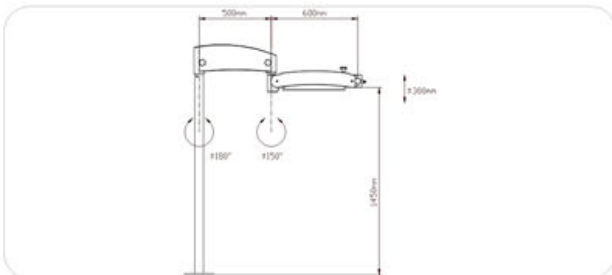
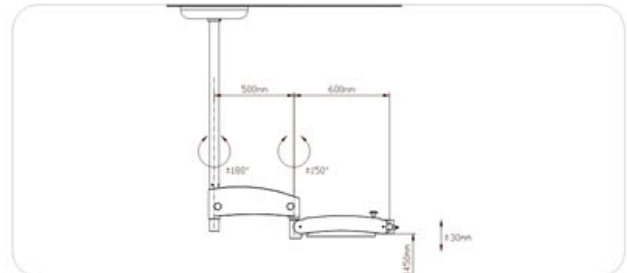
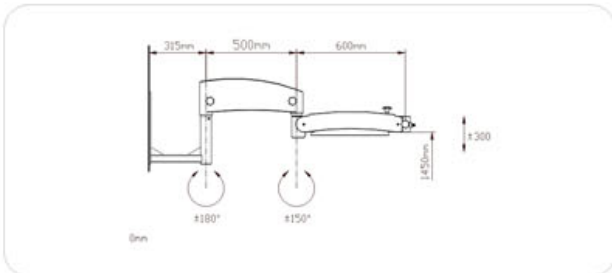

For more information, please contact:
ZUMAX MEDICAL CO., LTD.

36 Zhiying Street, Suzhou New District,
Suzhou, Jiangsu 215129, P. R. China
TEL. +81 512 6690 3235 FAX. +86 512 6690 9655
www.zumaxmedical.com Email: sales@zumaxmedical.cn